

dance of one part in 1250 and Oxygen 17 about one part in 10,000. All of the above figures are maximum estimates.

BERKELEY, CALIFORNIA

[CONTRIBUTION FROM THE DEPARTMENT OF CHEMISTRY, STANFORD UNIVERSITY]

## FURTHER EXPERIMENTAL TESTS OF THE GIBBS ADSORPTION THEOREM. THE STRUCTURE OF THE SURFACE OF ORDINARY SOLUTIONS

BY JAMES W. MCBAIN AND ROBERT DUBOIS

RECEIVED JULY 10, 1929

PUBLISHED DECEMBER 11, 1929

The present investigation was undertaken to determine by direct measurement the absolute amounts of various solutes adsorbed, or concentrated, at the air-solution interface. The experimental results throw further light on the structure of surface layers of solutions and in addition furnish data for the test of the validity of the Gibbs adsorption equations both in their strict form and in the approximate form commonly used. They fully substantiate the experimental findings of McBain and Davies<sup>1</sup> for the large amounts of solute transported on a moving bubble. It is now undeniable that a bubble moving through a solution actually transports far more solute than can be close packed into a monomolecular layer on its surface, and several fold greater than the amounts predicted from the classical theorem of Gibbs.

The Gibbs adsorption theorem may be expressed in the equivalent form

$$\Gamma = - \frac{d\sigma}{RT d \ln a} = - \frac{a}{RT} \times \frac{d\sigma}{da}$$

or, approximately

$$\Gamma = - \frac{d\sigma}{RT d \ln c} = - \frac{c}{RT} \times \frac{d\sigma}{dc}$$

where  $a$  is the activity of the solute and  $c$  its concentration,  $R$  is the gas constant, and  $T$  is the absolute temperature ( $\Gamma$ ,  $R$  and  $a$  or  $c$  being expressed, of course, in consistent units);  $d\sigma/dc$  is the slope of the surface tension/concentration curve at the concentration  $c$ .

These equations, particularly the last, have been used by numerous writers to calculate the surface concentrations of many substances. The results so obtained have generally been accepted with singular confidence in lieu of actual measurement and are still used as the basis of extensive deductions as to the structure of interfacial adsorption layers and of solution surfaces. It was and is of importance, therefore, that the validity of the equations should be tested experimentally. So far the evidence has been decidedly adverse. Agreement in one case cannot obscure disagreement in all others.

<sup>1</sup> J. W. McBain and G. P. Davies, *THIS JOURNAL*, 49, 2230 (1927).

**Previous Experimental Tests of the Gibbs Theorem.**—Experimental determinations of adsorption at fluid–fluid interfaces have been made by a number of workers, and these are collected in Table I. However, as McBain and Davies have proved, none of the results obtained by earlier workers has recorded the actually much larger amounts of solute transported by moving bubbles. This is due to the fact that all the solution, even that resulting from the collapse and escape of the bubbles, was con-

TABLE I  
A SUMMARY OF PREVIOUS WORK

Worker	Interface	Solutes studied	Comparison of obs. and calcd. "Gibbs' adsorption"
Milner <sup>2</sup>	Air–water	Sodium oleate	No comparison made
Lewis <sup>3</sup>	Oil–water	Non-electrolytes	Obs. 15 to 70 times calcd.
		Inorganic electrolytes	Obs. 6 to 30 times calcd.
	Hg–water	Aniline, caffeine, sodium glycolate, Hg <sub>2</sub> SO <sub>4</sub>	Obs. 3 to 25 times calcd.
Donnan and Barker <sup>4</sup>	Air–water	Nonylic acid, Saponine	Agreement claimed <sup>a</sup>
Griffin, <sup>5</sup> van der Meulen and Riemann, <sup>6</sup>			
Harkins <sup>7</sup>	Oil–water	Soaps	No comparison made
Oliphant and Burdon <sup>8</sup>	Hg–H <sub>2</sub> or Hg–A	Carbon dioxide	No comparison made
Schofield <sup>9</sup>	Hg–H <sub>2</sub> O	Mercurous salts	Agreement claimed <sup>10</sup>
McBain and Davies <sup>1</sup>	Air–water	<i>p</i> -Toluidine	Obs. 2 times calcd. <sup>b</sup>
		Amyl alcohol	Obs. 4 times calcd. <sup>b</sup>
		Camphor	Obs. 3 times calcd. <sup>b</sup>
Laing, McBain and Harrison <sup>11</sup>	Air–water	Sodium oleate	Obs. greater than calcd. and twice monomolecular adsorption
Harkins and Gans <sup>12</sup>	Air–water	Nonylic acid	Approximate agreement <sup>a</sup>
		Amyl alcohol	Obs. 3 times calcd. <sup>b</sup>

<sup>a</sup> Pumping action occurring in these experiments as well as others not marked.

<sup>b</sup> Pumping avoided.

<sup>2</sup> S. R. Milner, *Phil. Mag.*, [6] 13, 96 (1907).

<sup>3</sup> W. C. McC. Lewis, *ibid.*, [6] 15, 499 (1908); 17, 466 (1909); *Z. physik. Chem.*, 73, 129 (1910); *Science Progress*, 11, 199 (1916).

<sup>4</sup> F. G. Donnan and J. T. Barker, *Proc. Roy. Soc. (London)*, 85A, 557 (1911).

<sup>5</sup> E. L. Griffin, *This Journal*, 45, 1648 (1923).

<sup>6</sup> P. A. van der Meulen and Wm. Riemann, *ibid.*, 46, 876 (1924); 47, 2507 (1925).

<sup>7</sup> W. D. Harkins, "Colloid Symposium Monograph," Vol. V, 1927, p. 19.

<sup>8</sup> M. L. Oliphant and R. S. Burdon, *Nature*, 120, 584 (1927).

<sup>9</sup> R. K. Schofield, *Phil. Mag.*, [7] 1, 641 (1926).

<sup>10</sup> See criticism of J. A. V. Butler, *Proc. Roy. Soc. (London)*, 113A, 594 (1927).

<sup>11</sup> M. E. Laing, J. W. McBain and E. W. Harrison, "Colloid Symposium Monograph," Vol. VI, 1928, p. 63.

<sup>12</sup> W. D. Harkins and D. M. Gans, "Colloid Symposium Monograph," Vol. V, 1927, p. 40; Vol. VI, 1928, p. 36.

tained in connected apartments. Whenever a bubble entered the apparatus, it displaced its own volume of liquid into the next compartment and simultaneously from that to the next, and so on. Then as the bubble passed on to each successive compartment, that volume of solution necessarily returned to replace it. Since the liquid within each compartment was kept well stirred by the movement of the bubbles, each of the tens of thousands of bubbles passed in any one experiment acted as an efficient pump for mixing the initial impoverished solution with that from the middle compartments and the final enriched solution. The observed change was, therefore, necessarily far less than that which actually occurred. Even so it is remarkable that in nearly every case the results were far larger than those predicted. The simple expedient of allowing the bubbles to pass into a separate vessel before they collapse removes the possibility of loss by mixing.

It is seen from Table I that results for simple non-electrolytes, *p*-toluidine, camphor and amyl alcohol (confirmed by Harkins and by the present work), are far in excess of those possible according to the Gibbs equation. This discrepancy is not due to use of concentration in place of chemical potential in the Gibbs formula, for in the case of *p*-toluidine it makes no difference whether concentration or activity is used as the basis of the calculation.<sup>13</sup> Many further examples are adduced in the present paper.

The picture of the surface of an ordinary solution arrived at by McBain and Davies is that of a monomolecular surface layer of oriented molecules which serve as points of support for the growth of chains of oriented molecules relatively far into the solution, such chains being evanescent, being constantly broken up by thermal vibrations and as constantly replaced. It is very interesting that Sir William Hardy should have arrived independently at the same conclusion from quite other evidence.<sup>14</sup>

**Measurements of the Adsorption at the Air-Solution Interface.**—In the present work the method of McBain and Davies<sup>1</sup> was used to determine the adsorption at the air-solution interface of the following substances: phenol, *p*-toluidine, *iso*-amyl alcohol, resorcinol, thymol, acetic acid, butyric acid, caproic acid, nonylic acid and sodium chloride. The surface excess (or deficiency) of each of these substances was determined over a considerable concentration range and compared (a) with the amount predicted by application of the Gibbs equation both in the approximate and in the strict form and (b) with the amount required to complete a monomolecular surface layer both for vertical and for horizontal orientation of the adsorbed molecules. The surface tension and activity data were taken from the literature.

<sup>13</sup> J. W. McBain, W. F. K. Wynne-Jones and F. H. Pollard, "Colloid Symposium Monograph," Vol. VI, 1928, p. 57.

<sup>14</sup> W. B. Hardy, *J. Gen. Physiol.*, **8**, 641 (1927).

### Experimental Method

Gas bubbles were passed through an aqueous solution of the solute contained in a long, nearly horizontal glass tube of large diameter. The bubbles were caused to drain in a short vertical tube of smaller diameter and to pass over into and collapse in a descending portion of this tube. The liquid thus collected in a separate receiver contained not only the amount of solute to be found in an equal volume of the original solution but also the excess solute adsorbed on the surfaces of the bubbles. The absolute amount of this excess was determined by comparing the concentrations of collected liquid and original solution in a Zeiss interferometer. A number of values of  $\Gamma$  were determined successively in the course of a single experiment without interrupting the course of the bubbling. Nitrogen gas was used because of its inertness. The surface tension is considered to be the same as that at an air-solution interface.

The apparatus, shown diagrammatically in Fig. 1, consists essentially of a system  $S_1, S_2, S_3$  for saturating the nitrogen, an "adsorption tube" CD ending in the short vertical draining tube EF and a receiver  $B_2$ .

Nitrogen from a cylinder equipped with a pressure regulator is freed from carbon dioxide present by passage through strong potassium hydroxide solution in the gas washing bottles A, A. From these it passes in a steady stream of bubbles through the saturators,  $S_1, S_2, S_3$ , where it comes into equilibrium with a solution of exactly the same concentration as that in the adsorption tube. Many blank tests of the effectiveness of this saturating system were made by bubbling gas through the apparatus in the ordinary way but keeping the liquid supply shut off so that all bubbles collapsed in the horizontal tube. In most cases no change in concentration was produced.

The mercury manometer M is connected as shown. The capillary tube K serves to regulate and steady the flow of gas through the rest of the apparatus.

A constant stream of bubbles of the same size is formed at the specially shaped bubbling nozzle N and passes slowly along the tube CD filled with a solution of the solute whose adsorption is to be determined. Here adsorption, if any, takes place at the surface of the bubbles. Each bubble finally rises through the tube EF, where it joins a column of nearly cylindrical, rapidly draining films, which are continually passing over the bend at F and being replaced from behind. The appearance of this column of films is shown in Fig. 2. The time required for passage along the tube CD is about twelve seconds, for the tube EF about one and one-half seconds.

The films with their adsorbed surface layers collapse in the descending tube FGH, and the liquid from these collects in the receiver  $B_2$ , which is a 100-cc. buret attached to

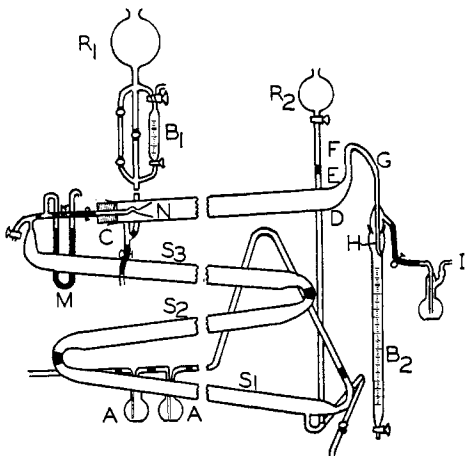

Fig. 1.—The adsorption apparatus.

GH by a ground-glass connection and equipped with a large-bore glass stopcock for rapid emptying. The nitrogen released by collapse of the bubbles leaves the apparatus at I and passes through a gas meter (Boys bell meter). The end of the tube GH was beveled and bent so as to touch the side of the buret. The effect of this detail was to cause the complete collapse of any films which had reached this orifice still unbroken. The end of the buret outlet was cut off close to the stopcock to reduce the amount of liquid remaining in this part.

The reservoirs,  $R_1$  and  $R_2$ , are for supplying liquid to the adsorption and the saturating tubes, respectively. The means of emptying the apparatus are shown in the drawing.

#### DIMENSIONS OF THE APPARATUS

Tube	CD	EF	$S_1, S_2, S_3$
Inside diameter, cm.	2.5	0.86	1.8
Length, cm.	156	8	120
Slope, %	4-8	Vertical	8

#### Procedure

At the beginning of each new study the entire apparatus and all glassware to be used were cleaned thoroughly with hot  $H_2SO_4-K_2Cr_2O_7$  mixture and rinsed repeatedly with distilled water. The aqueous solutions were made up in most cases with boiled out distilled water and a fresh solution was used for each experiment except in the first and the last few runs, in which cases the solution was carefully protected after use and remixed for the next experiments.

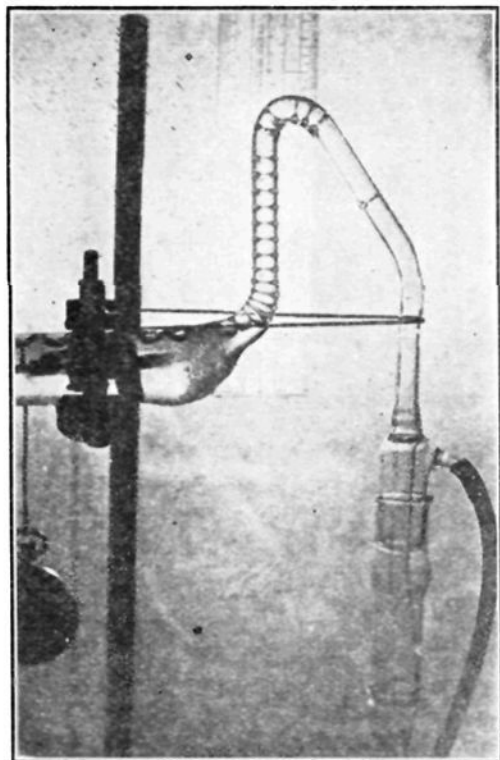

Fig. 2.—Detail of adsorption apparatus.

The adsorption apparatus and the collecting bottles were rinsed with the solution and the entire apparatus was filled. Bubbling was then started and the time noted. The bubble rate and the supply of liquid from reservoir  $R_1$  were adjusted until a stable column of cylindrical films was formed in the draining tube EF and passed over unbroken into the descending tube FGH. During this time collapsed film liquid was allowed to run out of the buret and was not collected.

The adsorption experiment proper was started by closing the stopcock of the receiver-buret, and time and meter reading were noted. After any desired amount of liquid had collected in the receiver, the time was noted, the meter read and the collected liquid run out into a weighed,

stoppered bottle. The collection of samples of collapsed film liquid was repeated as many times as desired in exactly the same way, and independent values of  $\Gamma$  were calculated from the separate sets of data. At the close of the run the liquid remaining in the adsorption tube was withdrawn and its concentration compared with that of the original solution. The total change in concentration (usually a loss) was distributed over the whole period of the run, and the observed concentration changes in the samples of collected film liquid were recalculated with reference to the mean concentration of the solution with which the bubbles were in contact at the time of collection.

**Analysis of Solutions.**—The analysis was made with a Zeiss interferometer for liquids. The following table shows the calibration equivalents for  $1^\circ$  determined in grams per cubic centimeter.

TABLE II  
INTERFEROMETER CALIBRATION EQUIVALENTS<sup>a</sup>

Substance	Value of 1 division in g./cc. $\times 10^6$		
	2-cm. cell	4-cm. cell	8-cm. cell
Phenol	4.2	(2.0)	
<i>p</i> -Toluidine	3.18	1.54	(0.73)
<i>Iso</i> -amyl alcohol		3.93	1.91
Resorcinol		1.9	(0.91)
Thymol			1.14
Acetic acid		5.74	
Butyric acid		1.63	
Caproic acid		4.00	
Nonylic acid		2.18	
Sodium chloride		2.35	
Menthol			3.3

<sup>a</sup> Numbers in parentheses were calculated in each case by multiplying the actually determined calibration value for another cell (in terms of the same substance) by the ratio of the calibration values of these two cells for a different substance. For example, 1 division (4-cm. cell) =  $2.0 \times 10^{-6}$  g./cc. of phenol =  $4.2 \times 10^{-6} \times 1.54/3.18$  (ratio from *p*-toluidine calibrations).

In the analysis great care was taken to ensure freedom from external contamination, to prevent evaporation changes and to secure uniformity of temperature—precautions especially necessary because the interference bands by which the comparisons are made are very easily distorted and shifted by small temperature inequalities in the solutions being measured and because the concentration changes observed were, at the most, very small relative to the total concentration of the solutions used.

### Calculation of Results

The adsorption  $\Gamma$  is the absolute excess of solute transported on the bubble surfaces divided by the total adsorbing surface and is expressed in this paper in grams per square centimeter  $\times 10^{-8}$ .

$$\Gamma = \frac{1^\circ \times r \times V_c \times S_c^m}{2V_g + 2\pi r^2 B}$$

where  $V_c$  is the volume of solution collected, determined by weight, assuming unit density;  $S_c^m$  is the change in interferometer readings corrected with reference to the mean concentration of the solution during its collection;  $V_g$  is the volume of gas and  $B$  the number of bubbles passed during the collection of one complete sample. It is assumed that each bubble is a cylinder of radius 0.43 cm. At least 100 sq. cm. of bubble surface should pass over for each cubic centimeter of collapsed liquid collected; that is, the effective depth of the surface studied should not exceed 0.1 mm.

On account of the great difficulty of counting visually the number of bubbles when the rate was high (usually over 200 and frequently 300 to 400 a minute) an automatic, electrical apparatus was devised for the purpose (Fig. 3). By this means the total number of bubbles passing could be determined directly and with accuracy, and observations of duration and bubble rate were no longer necessary for the final calculation.

In Fig. 3 CB is a detail of the adsorption tube showing the bubbling nozzle equipped with a circuit breaking device which consisted of two platinum wires sealed into glass tubes on opposite sides of the nozzle

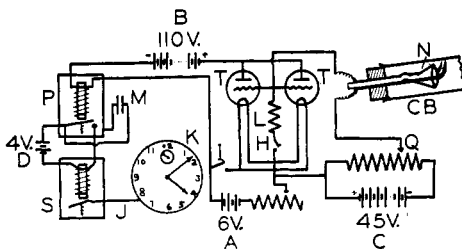

Fig. 3.—The electrical bubble counter.

and arranged so that the protruding tips of the wires extended vertically up into the path of the bubbles leaving the nozzle. As each bubble passed, the platinum points pierced it (without affecting its stability) and thus became separated by a non-conducting gaseous gap.

The circuit breaker was inserted in the grid circuit of a three-electrode vacuum tube. Power amplifier tubes

T,T were used of such characteristics that a normal plate current of about 30 milliamperes flowed when the plate voltage B was 110 volts, the filament voltage A 6 volts and the grid voltage zero. By means of a voltage divider circuit Q connected to a 45-volt dry battery C the optimum (negative) voltage could be applied to the grid. The negative terminal of the C battery was connected through the circuit breaker to the grid (positive terminal to filament). The negative voltage thus applied reduced the plate current to zero, and because of the rectifying action of the tube no current flowed through the grid circuit and so *no electrolysis took place in the solution*.

When a bubble passed over the platinum points and broke the circuit, the grid charge was immediately dissipated through the grid leak L (2 megohms), and the full current passed through the plate circuit of the tube. In order to double the amplification effect the two power tubes T,T were connected in parallel and their plate currents were fed through a single circuit.

A 150-ohm telegraph relay P was inserted in the plate circuit with suitable capacity across the points (2 mfd. condenser M). The secondary terminals of this relay were connected in series with a circuit composed of a 4-volt source of direct current D and a 20-ohm telegraph relay S.

A clock K was used as a mechanical counting device. After removal of hair spring

and balance wheel the escapement lever was connected through J to the armature of relay S, whose movements therefore actuated the escape wheel movement. Two readings of the "apparent time," translated into seconds and multiplied by 2 (gear ratio of escape wheel to seconds wheel), gave the total number of bubbles which had passed during the interval.

The counter works best with solutions of low conductivity. When the conductivity becomes large, a conducting film of liquid is left on the surface of the platinum wires and the glass tubes during the passage of the bubble, and the grid circuit is thus continued down the outside of the wires and across the solution at the surface of the bubble.

Thymol c. p. from Coleman and Bell and Eastman caproic acid were used, Kahlbaum caproic acid being apparently less pure and giving a lower value. The other chemicals were the best obtainable from Kahlbaum. *p*-Toluidine was further purified by sublimation and this doubled the amount of sorption, making it the same as that found by McBain and Davies.

To save space the results are given only as points on the graph but each of these points is the mean of at least five and in many cases more experiments. The value of  $\Gamma$  for 3.0 g. of *iso*-amyl alcohol per liter is the mean of 129 measurements and is  $11.0 \times 10^{-8}$  as compared with the predicted Gibbs value  $3.0 \times 10^{-8}$ .

Negative adsorption was demonstrated in the experiments with aqueous sodium chloride, for which Harkins and McLaughlin<sup>15</sup> and Goard and Rideal<sup>16</sup> had simultaneously predicted from activity data a negative sorption approximately equivalent to the complete absence of sodium chloride from the first layer of water molecules on the surface. At first sight these experiments would seem to be impossible since stable bubbles or films will not rise from strong solutions of sodium chloride. However, it was discovered in experiments with caproic acid that with our apparatus it made very little difference to the results if the films were broken before

TABLE III

CROSS SECTIONS AND AREAS OF MOLECULES DEDUCED FROM LITERATURE ON THIN FILMS AND ON X-RAYS, AND HENCE THE AMOUNTS OF ADSORPTION PREDICTED FOR A CLOSE-PACKED MONOMOLECULAR LAYER

Solute adsorbed	Minimum area per molecule, Å. <sup>2</sup>		Monomolecular adsorption, g./cm. <sup>2</sup> × 10 <sup>8</sup>	
	Vertical orientation	Horizontal orientation	Vertical orientation	Horizontal orientation
Amyl alcohol	21	39	6.7	7.4
Acetic acid	21	21	5.2	5.2
Butyric acid	21	32	6.9	4.5
Caproic acid	21	45	9.2	4.3
Nonylic acid	21	61	12.4	4.3
Phenol	24	39	6.5	3.9
<i>p</i> -Toluidine	24	45	7.4	3.9
Resorcinol	28	46	6.6	3.9
Thymol	38	..	6.6	...

<sup>15</sup> W. D. Harkins and H. M. McLaughlin, THIS JOURNAL, 47, 2083 (1925).

<sup>16</sup> A. K. Goard and E. K. Rideal, J. Chem. Soc., 127, 1668 (1925).



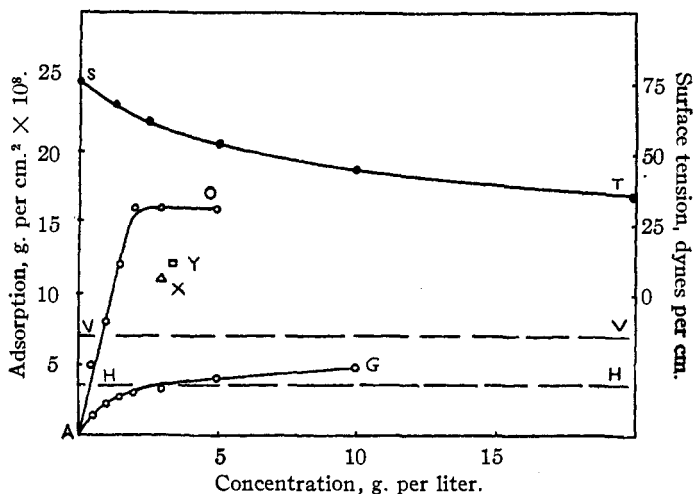

Fig. 4.—Adsorption of amyl alcohol. ST, Surface tension (15°) according to Edwards;<sup>17</sup> AO, adsorption observed by McBain and Davies;<sup>1</sup> X, adsorption observed by writers (mean of 129 measurements); Y, adsorption observed by Harkins and Gans;<sup>12</sup> AG, adsorption calculated (25°) by Gibbs concentration formula; VV, monomolecular adsorption (vertical orientation); HH, monomolecular adsorption (horizontal orientation).

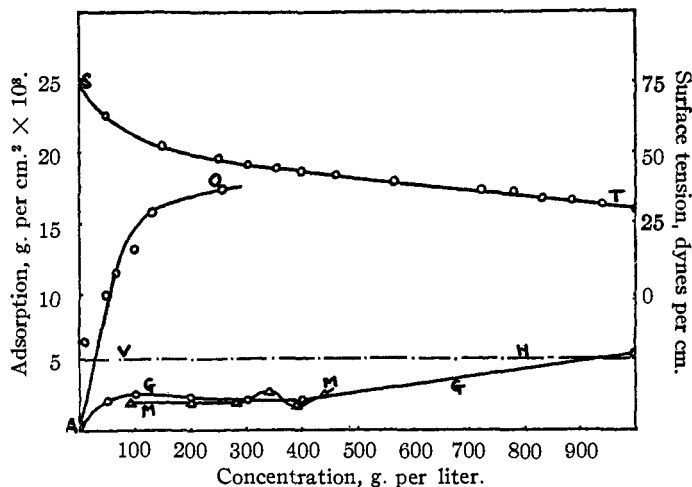

Fig. 5.—Adsorption of acetic acid. ST, surface tension according to Whatmough;<sup>18</sup> AO, adsorption observed; AGG, adsorption calculated by the Gibbs concentration formula (25°); MM, adsorption calculated by Milner<sup>2</sup> from same data and formula; VH, monomolecular adsorption (vertical or horizontal orientation).

<sup>17</sup> P. R. Edwards, *J. Chem. Soc.*, 127, 744 (1925).

<sup>18</sup> W. H. Whatmough, *Z. physik. Chem.*, 39, 129 (1902).

passing over the bend, provided that a steady flow of liquid slightly larger than usual was allowed to pass over continuously. Using this device the actual deficiency of salt in the liquid flowing over was four to eight times larger than that predicted by the Gibbs equation.

**Comparison of Observed, "Gibbs" and Monomolecular Adsorption.**— Inspection of the curves, Figs. 4 to 13, shows that the adsorption calculated from the approximate (concentration) Gibbs equation increases rapidly with concentration, attains a maximum while the solution is yet fairly dilute and the surface tension is still decreasing, and then drops

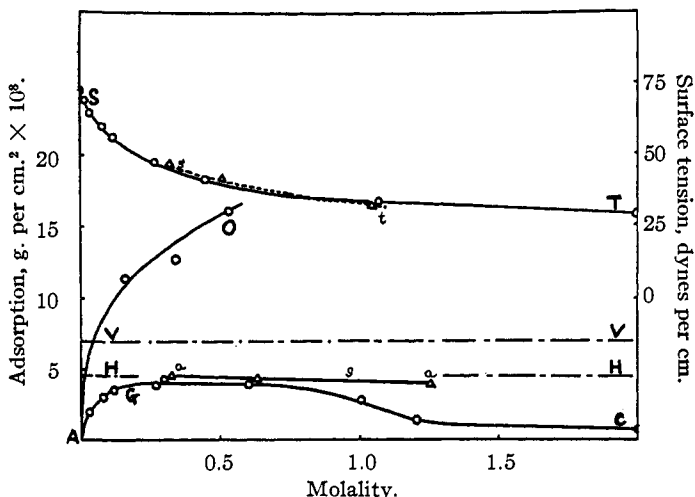

Fig. 6.—Adsorption of butyric acid. ST, surface tension (25°), according to Drucker,<sup>19</sup> plotted against molality; ST, surface tension plotted against activity on same scale as molality; AO, adsorption observed; AGC, adsorption calculated (25°) by Gibbs concentration formula; aga, adsorption calculated (25°) by Gibbs activity formula (activity data from Bury);<sup>20</sup> VV, monomolecular adsorption (vertical orientation); HH, monomolecular adsorption (horizontal orientation).

in a way for which it would be difficult to account on a physical basis. The effect of using the exact equation involving activity, as is shown in the graphs, makes but little difference for the lower concentrations of the simple substances we have selected for study, but it frees the curves from the anomalous decrease in concentrated solutions.

It should be pointed out that "Gibbs" adsorption is not, as commonly supposed, necessarily identical with monomolecular adsorption, although the number of times the maximum "Gibbs" value approximates either one or the other of the monomolecular values is indeed suggestive of a physical reality for the calculated quantity which may be more than fortuitous.

<sup>19</sup> K. Drucker, *Z. physik. Chem.*, **52**, 641 (1905).

<sup>20</sup> C. R. Bury, *Phil. Mag.*, [7] **4**, 980 (1927).

However, the large number of experimental results obtained by McBain and Davies and in the present work indicate very strongly that the Gibbs equation does not supply real values. Of the ten substances investigated in this Laboratory, eight have been found to be adsorbed in amounts which are from two to eight times that predicted by the Gibbs theorem. The plotted curves show this very strikingly. A possible explanation of the relatively lower results obtained with thymol and nonylic acid is given below.

The amounts found to be adsorbed are from two to four times the quantities which could be accommodated in a monomolecular surface layer

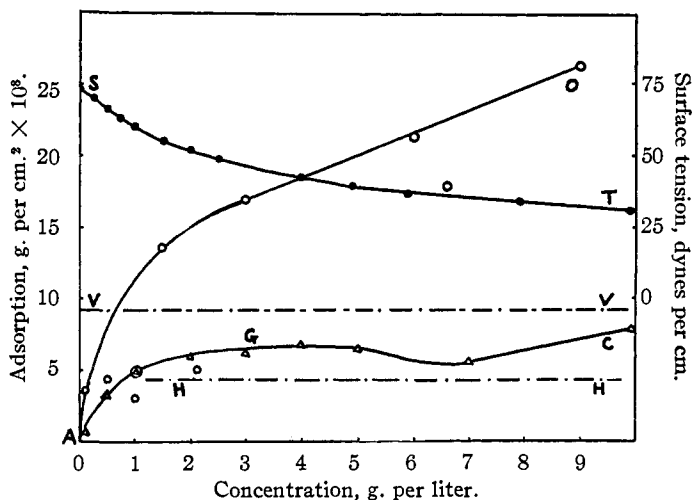

Fig. 7.—Adsorption of caproic acid. ST, surface tension ( $19^{\circ}$ ) according to Szyszkowski;<sup>21</sup> AO, adsorption observed; AGC, adsorption calculated ( $25^{\circ}$ ) by Gibbs concentration formula; VV, monomolecular adsorption (vertical orientation); HH, monomolecular adsorption (horizontal orientation).

of vertically oriented molecules with even the closest packing ever observed in condensed films of related compounds. The adsorption effect must, therefore, extend beyond one molecular dimension and the results support McBain's suggestion<sup>1</sup> as to the structure of adsorbed layers at solution surfaces.

### Discussion

These moving surfaces carry several times more solute than is compatible with the equation of Gibbs, and yet nearly all the experimental errors would seem to be operating so as to prevent the full real adsorption from being shown. Satisfactory blank tests have shown that the obvious experimental errors, such as incomplete saturation of the gas, have been

<sup>21</sup> B. von Szyszkowski, *Z. physik. Chem.*, **64**, 385 (1908).

eliminated. The following effects would tend to counterbalance part of the true adsorption: (a) traces of contamination or impurity, such as a trace of grease from the stopcocks; (b) the frictional resistance to the movement of the cylindrical walls of the drained bubbles, as discussed by McBain and Davies (in the present work the ratio between radius and length was always between 0.6 and 1.0); (c) if the bubbles were spheres instead of true cylinders, all recorded results should be increased by 10%; (d) the shortness of time (about sixteen seconds) allowed for adsorption

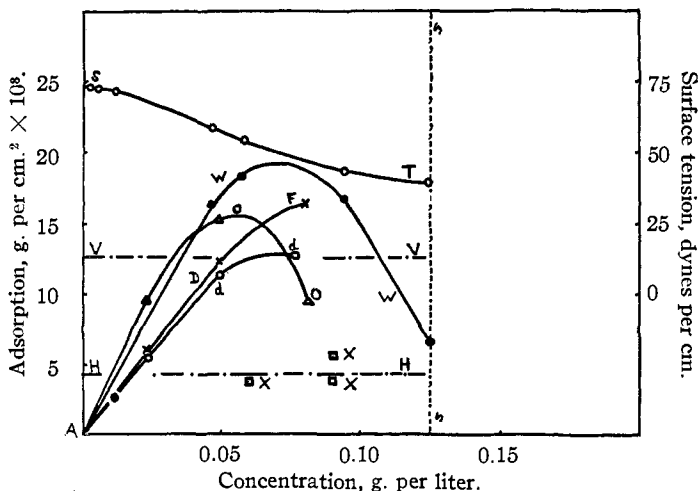

Fig. 8.—Adsorption of nonylic acid. ST, surface tension (18°) according to Forch;<sup>22</sup> AOO, adsorption observed by Donnan and Barker;<sup>4</sup> X, adsorption observed by the writers; ADF, adsorption calculated by Donnan and Barker by Gibbs concentration formula from Forch's S. T. data; Add, adsorption calculated by Donnan and Barker from own S. T. data; AWF, adsorption calculated by writers from Forch's S. T. data; VV, monomolecular adsorption (vertical orientation); HH, monomolecular adsorption (horizontal orientation); ss, saturated solution.

to occur; (e) the rubbing of the bubble against the liquid would tend to strip off the more loosely held molecules and chains so that the dynamic surface would sorb less than a motionless static one.

The *ad hoc* assumption has been made in several quarters that adsorption of the substances we have used is quick and desorption abnormally slow, although there is no evidence whatever for this assumption. The idea is that the moving bubble could thus accumulate an undue excess of material in its rear. However, closer examination of the processes of diffusion involved in adsorption renders this assumption less attractive. The extent of the Gibbs adsorption is entirely conditioned by the rate at which

<sup>22</sup> C. Forch, *Wied. Ann.*, **68**, 801 (1899).

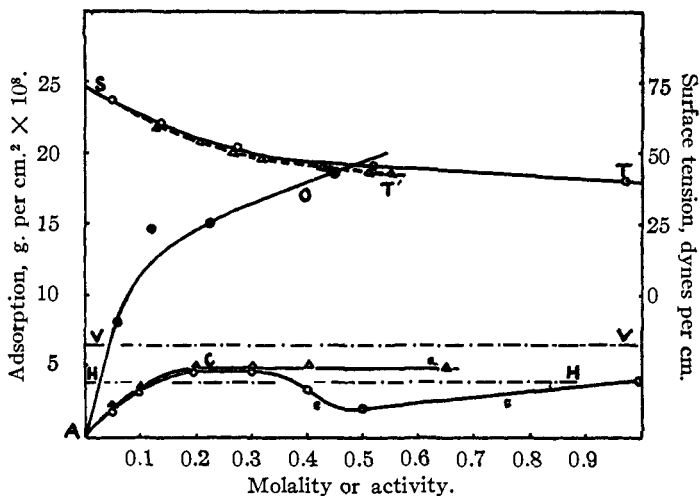

Fig. 9.—Adsorption of phenol. ST, surface tension plotted against molality, data of Goard and Rideal;<sup>18</sup> ST', surface tension plotted against activity, data of Jones and Bury;<sup>23</sup> AO, adsorption observed; ACa, adsorption calculated from activity formula; Acc, adsorption calculated from concentration formula; VV, monomolecular adsorption (vertical orientation); HH, monomolecular adsorption (horizontal orientation).

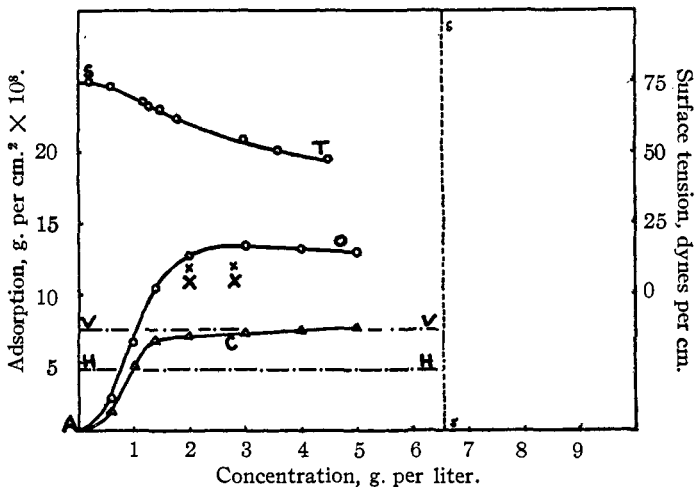

Fig. 10.—Adsorption of *p*-toluidine. ST, surface tension, according to Edwards;<sup>17</sup> AO, adsorption observed by McBain and Davies;<sup>1</sup> X, adsorption observed by writers; AC, adsorption calculated from concentration formula; VV, monomolecular adsorption (vertical orientation); HH, monomolecular adsorption (horizontal orientation); ss, saturated solution.

<sup>23</sup> E. R. Jones and C. R. Bury, *Phil. Mag.*, [7] 4, 841 (1927).

the solute molecules diffuse into the depleted portions of the solution in more immediate contact with the bubble. An instantaneous adsorption would be zero adsorption according to the Gibbs definition. This

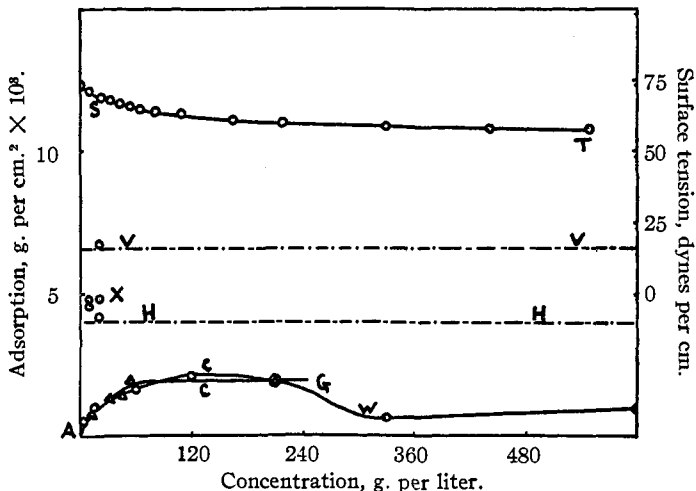

Fig. 11.—Adsorption of resorcinol. ST, surface tension according to Harkins and Grafton;<sup>24</sup> X, adsorption observed by the writers; ACW, adsorption calculated by the writers from the concentration formula; ACG, adsorption calculated by Harkins and Grafton.

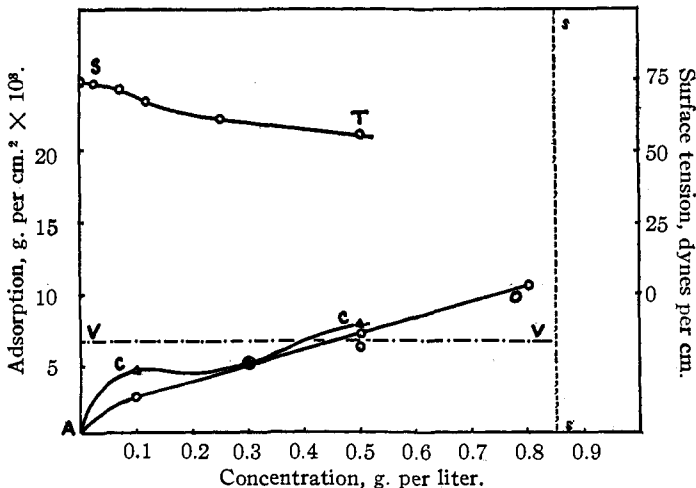

Fig. 12.—Adsorption of thymol. ST, surface tension, according to Edwards;<sup>17</sup> AO, adsorption observed; ACC, adsorption calculated from concentration formula; ss, saturated solution; VV, monomolecular adsorption (vertical orientation).

<sup>24</sup> W. D. Harkins and E. H. Grafton, *THIS JOURNAL*, 47, 1330 (1925).

diffusion rate is proportional to the difference in concentration between the solution in this region and that in the bulk phase. In very dilute solutions, in addition to smaller diffusion rate, the molecules have to diffuse from a far greater distance to supply the absolute amount of material adsorbed at the surface, and one would therefore expect low results with such solutions as those of thymol and nonylic acid. However, the practical effect of setting up the *ad hoc* assumption referred to is to discard all measurements made by the dynamic method, and there are no others that have been satisfactorily substantiated. The present custom of using the Gibbs theorem instead of experiment seems decidedly artificial.

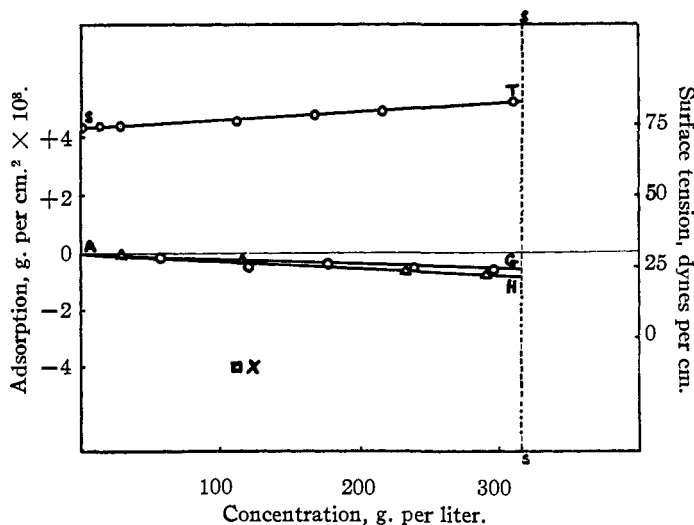

Fig. 13.—Negative adsorption of sodium chloride. ST, surface tension according to "International Critical Tables," Vol. IV, p. 465; AG, adsorption calculated by Goard<sup>25</sup> from the activity formula; AH, adsorption calculated from data of Harkins and McLaughlin<sup>15</sup> based on activities; X, adsorption observed; ss, saturated solution.

We are seeking a decision by the use of static surfaces, and the preliminary measurements with several substances indicate an even greater adsorption and therefore a greater discrepancy between experiment and either the treatment of Gibbs or the limited adsorption corresponding to a monomolecular film.

Further communications will deal with such experiments and with a discussion of the electrical terms ignored in the Gibbs equation.

### Summary and Conclusions

1. The method of McBain and Davies has been used to measure the adsorption at the surface of solutions of *iso*-amyl alcohol, acetic, butyric,

<sup>25</sup> A. K. Goard, *J. Chem. Soc.*, 127, 2451 (1925).

caproic and nonylic acids, phenol, *p*-toluidine, resorcinol, thymol, camphor and sodium chloride.

2. When a bubble passes through a solution of a simple substance, it carries with it from 2 to 8 times as much of the solute as is predicted by the Gibbs adsorption theorem either in its exact or in its approximate form. The amounts carried are from 2 to 4 times that which can be accommodated in a monomolecular film of closely packed, vertically oriented molecules.

These findings fully substantiate those of McBain and Davies and support the views of McBain and of Hardy as to the constitution of surfaces of ordinary solutions.

STANFORD UNIVERSITY, CALIFORNIA

---

[CONTRIBUTION FROM THE CHEMICAL LABORATORIES OF HARVARD UNIVERSITY AND OF STANFORD UNIVERSITY]

## THE PHOTOCHEMICAL DECOMPOSITION OF BENZOQUINONE IN WATER AND IN ALCOHOL

BY PHILIP ALBERT LEIGHTON AND GEORGE SHANNON FORBES

RECEIVED JULY 24, 1929

PUBLISHED DECEMBER 11, 1929

Parabenzoquinone, stable in the solid phase, can be photolyzed in alcohol or water solutions. In alcohol the products are acetaldehyde, hydroquinone and a third more complex product.<sup>1</sup> In water hydroquinone and a larger amount of the complex product are formed. Hartley and Leonard<sup>2</sup> found for the complex product approximately the formula of a dimer.

A similar photochemical decomposition of quinone in ether, glycerin, benzaldehyde, acetaldehyde, toluene, carbon tetrachloride and other solvents has been reported.<sup>3</sup>

Hartley and Little<sup>4</sup> made a qualitative study of the quinone photolysis, and a number of measurements of the absorption spectra of quinone solutions have been made<sup>5,2</sup> chiefly with reference to theories of the structure of the quinone "chromophore."

<sup>1</sup> Ciamician and Silber, *Ber.*, **19**, 2899 (1886); **34**, 1530 (1901).

<sup>2</sup> Hartley and Leonard, *J. Chem. Soc.*, **95**, 34 (1909).

<sup>3</sup> Ciamician and Silber, *Ber.*, **35**, 1080 (1902); **36**, 1575, 4128 (1903); Klinger and Standke, *ibid.*, **24**, 1340 (1891); Klinger, *ibid.*, **19**, 1864 (1886); **24**, 1340 (1891); Klinger and Kolvenbach, *ibid.*, **31**, 1214 (1898).

<sup>4</sup> Hartley and Little, *Proc. Chem. Soc.*, **27**, 137 (1911); *J. Chem. Soc.*, **99**, 1079 (1911).

<sup>5</sup> Hartley, Dobbie and Lander, "British Association Report," 1902, p. 107; Hartley, *J. Chem. Soc.*, **95**, 52 (1909); Baly and Stewart, *ibid.*, **89**, 506 (1906); Purvis, *ibid.*, **123**, 1841 (1923); Klingstedt, *Compt. rend.*, **176**, 1550 (1923); Lifschitz and collaborators, *Rec. trav. chim.*, **43**, 269, 403, 654 (1924); *Z. Physik*, **38**, 61 (1926); Light, *Z. Physik. Chem.*, **122**, 414 (1926); Marchlewskii and Moroz, *Bull. soc. chim.*, **35**, 473 (1924).